

American Bollard

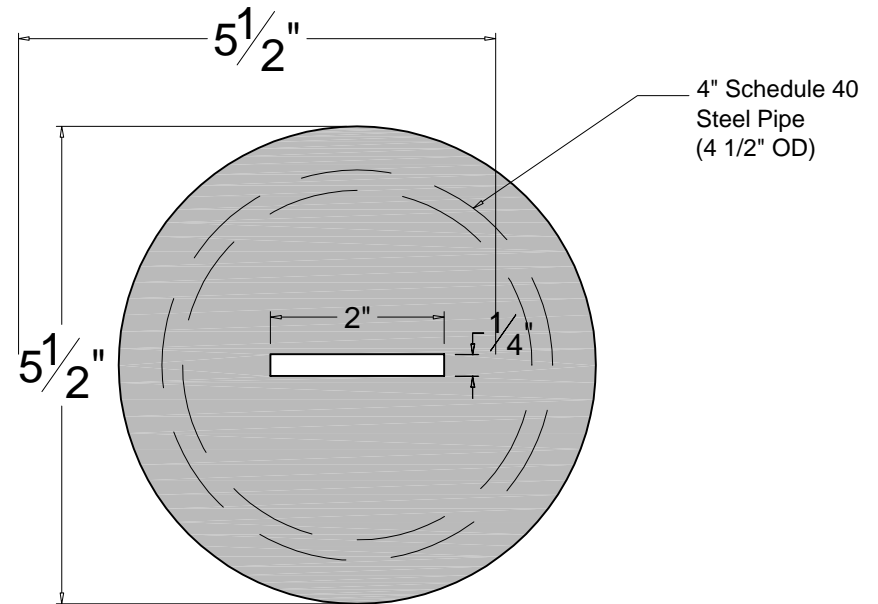
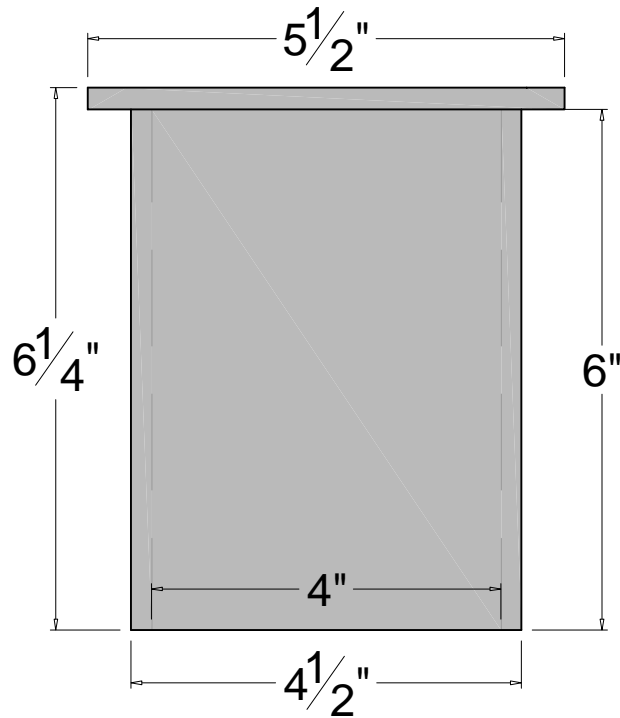

Customer Approval

Approved by: _____

Print Name: _____

Date: _____

Rev. 2-14-08

THIS DRAWING IS NOT DRAWN TO SCALE
Copyright 2006-2008 Architectural Iron Company, Inc. All rights reserved.

THIS DRAWING IS AN INSTRUMENT OF PROFESSIONAL SERVICE AND SHALL REMAIN THE PROPERTY OF ARCHITECTURAL IRON COMPANY WHETHER THE PROJECT FOR WHICH IT IS PREPARED IS EXECUTED OR NOT. NO CHANGES, ALTERATIONS, ADDITIONS, OR DELETIONS MAY BE MADE EXCEPT BY ARCHITECTURAL IRON COMPANY. THIS DRAWING SHALL NOT BE REPRODUCED BY ANYONE ON OTHER PROJECTS, FOR ADDITIONS TO THIS PROJECT, OR FOR COMPLETION OF THIS PROJECT BY OTHERS WITHOUT WRITTEN CONSENT.

This drawing is available in AutoCad format.

Material used is steel
unless otherwise specified.

Due to the casting process actual
measurements may vary slightly.



Architectural Iron Company

104 Ironwood Court / P.O. Box 126
Milford, PA 18337

800-442-IRON/4766

Fax: 570-296-IRON /4766

www.architecturaliron.com

E-mail: info@architecturaliron.com

Bollard Plug for AIC-757758R

Drawing No.	Drafted By:	Checked By:	Date:	Part Number
AIC-757758RP	B. Hale	D.Q.	07/16/07	AIC-757758RP