

American Bollard

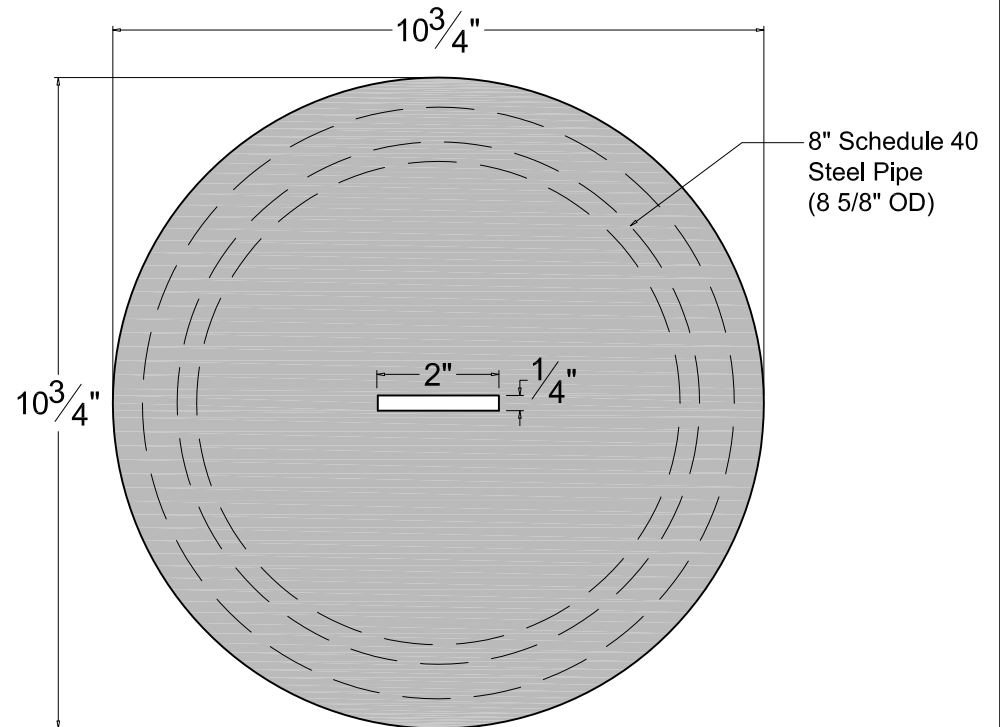
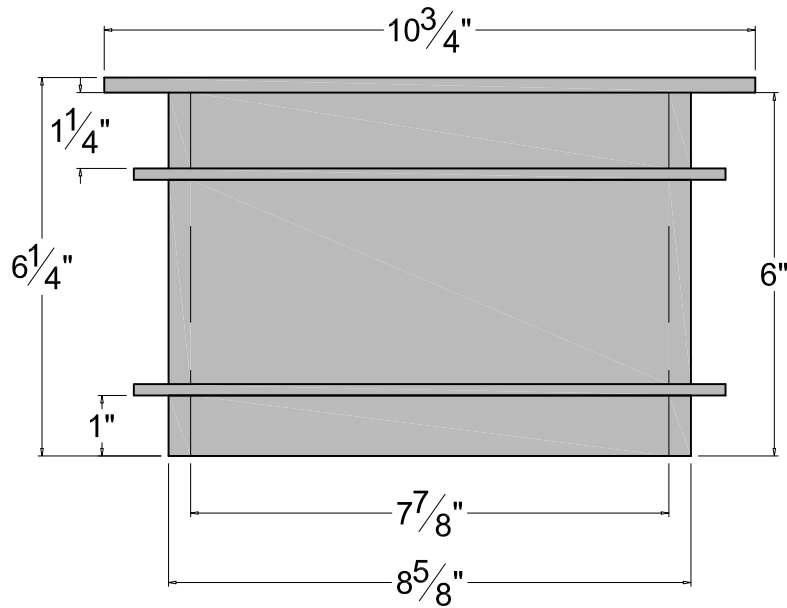

THIS DRAWING IS NOT DRAWN TO SCALE
 Copyright 2006-2016 Architectural Iron Company, Inc. All rights reserved.

THIS DRAWING IS AN INSTRUMENT OF PROFESSIONAL SERVICE AND SHALL REMAIN THE PROPERTY OF ARCHITECTURAL IRON COMPANY WHETHER THE PROJECT FOR WHICH IT IS PREPARED IS EXECUTED OR NOT. NO CHANGES, ALTERATIONS, ADDITIONS, OR DELETIONS MAY BE MADE EXCEPT BY ARCHITECTURAL IRON COMPANY. THIS DRAWING SHALL NOT BE REPRODUCED BY ANYONE ON OTHER PROJECTS, FOR ADDITIONS TO THIS PROJECT, OR FOR COMPLETION OF THIS PROJECT BY OTHERS WITHOUT WRITTEN CONSENT.

This drawing is available in AutoCad format.

Material used is steel
 unless otherwise specified.

Due to the fabrication process actual
 measurements may vary slightly.



Architectural Iron Company

104 Ironwood Court / P.O. Box 126
 Milford, PA 18337

800-442-IRON/4766

Fax: 570-296-IRON/4766

www.architecturaliron.com

E-mail: info@architecturaliron.com

Plug for AIC 957-958R Smooth Shaft Bollards

Drawing No.	Drafted By:	Checked By:	Date:	Part Number
AIC-957-958RP	J. Roberts	-	7/21/16	AIC 957-958RP